

P/N: FAPE3018149

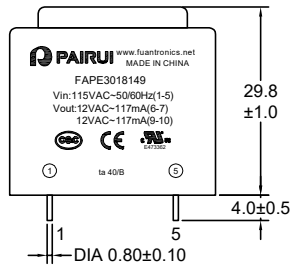

Outline Dimensions(Unit:mm)



Front View



Side View

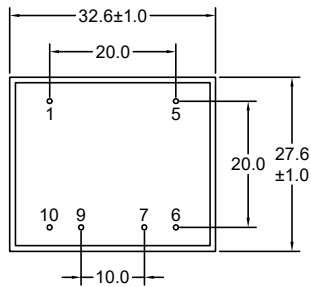

Bottom View

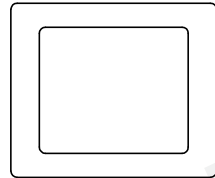

Top View

Note:

1.Remove Pins 2,3,4,8.

Wave Soldering



Note:
1.Never Contact the ceramic with the iron tip;
2.1.0mm tip diameter(max).

Electronical Schematic

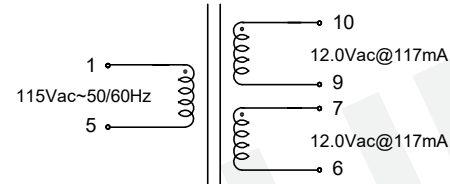

Electrical Characteristics

Input 115Vac 60Hz to 1-5 :
Excitation current(Ix):15.0mA Max.
Output: Vo(6-7)=21.1Vac Typ(No-load).
Vo(9-10)=21.1Vac Typ(No-load).
VL(6-10 short7,9)=24.0Vac±5%(Series@117mA).
VL(6,9-7,10)=12.0Vac±5%(Parallel@234mA).
Insulation Resistance: Pri-Sec:100 Mohms Min @500V.
Hi-Pot: Pri-Sec:4000VAC/5mA/60Second.

General Properties

Operating Temperature:-25°C to +40°C.
Storage Temperature:-25°C to +85°C.
Insulation Class: B.

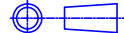
REV	DESCRIPTION	APPD	DATE	Tianchang Fuan Electronic Co Ltd www.fuantronics.net TEL: +86-550-7814888 FAX: +86-550-7831133	 Tolerances unless otherwise specified: (X)±0.50 (XX)±0.25 Unit of measurement: mm	Make: Qiumei.Liu	DRAWING TITLE 2.80W Encapsulated Transformer For E130*18,115VAC Input 50/60Hz	Customer Name:
						Checked: Beson. zhan		Document/Rev: 00
				Approved: Anson. zhan	Material Number: A223018XS920	Specification Sheet: 1 of 3		Date of Recognition: Jan./02/2020

P/N: FAPE3018149



List of UL Certificate:

No.	Part Name	Mat'l Description	Supplier	UL Number
1	Bobbin	EI30*18/PBT(Black)	Chang Chun Plastics Co Ltd	E59481
2	Case	CASE-EI30*18/PA66(Orange)	Zhejiang Juner New Materials Co Ltd	E204321
3	Copper wire	2UEW-F/155C	Elektrisola Hangzhou Co Ltd	E258243
4	Core	Lamination	Ta Yea Steel Industry Co Ltd	N/A
5	Epoxy	PU552(Black)	Wevo-Chemle Gmbh	E108835
6				

Packaging Specification:

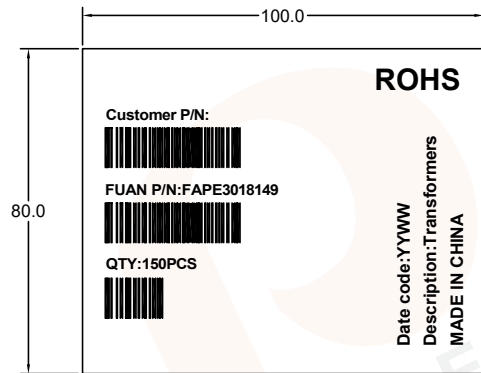

Laber of outer

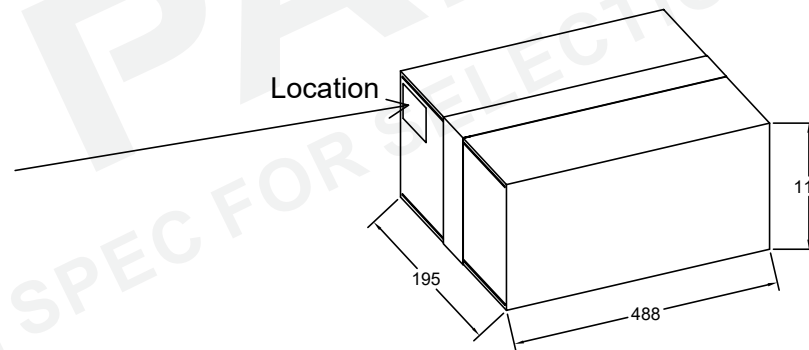

put the label on the top left corner of one of the carton sides

				Tianchang Fuan Electronic Co Ltd www.fuantronics.net TEL: +86-550-7814888 FAX: +86-550-7831133	 Tolerances unless otherwise specified: (.X)±0.50 (XX)±0.25 Unit of measurement: mm	Make: Qiumei.Liu Checked: Beson. zhan Approved: Anson. zhan	DRAWING TITLE 2.80W Encapsulated Transformer For EI30*18,115VAC Input 50/60Hz Material Number: A223018XS920	Customer Name: Document/Rev: 00 Specification Sheet: 2 of 3 Date of Recognition: Jan./02/2020
REV	DESCRIPTION	APPD	DATE					

P/N: FAPE3018149

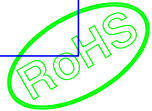

Packing Method:

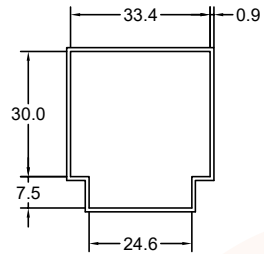
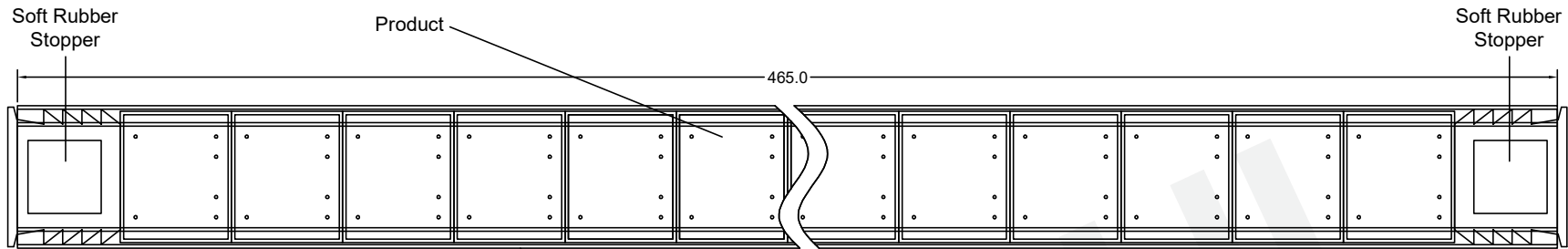

Size of packaging tube:
465mm*35.2mm*39.3mm
(Length * Width * Height)

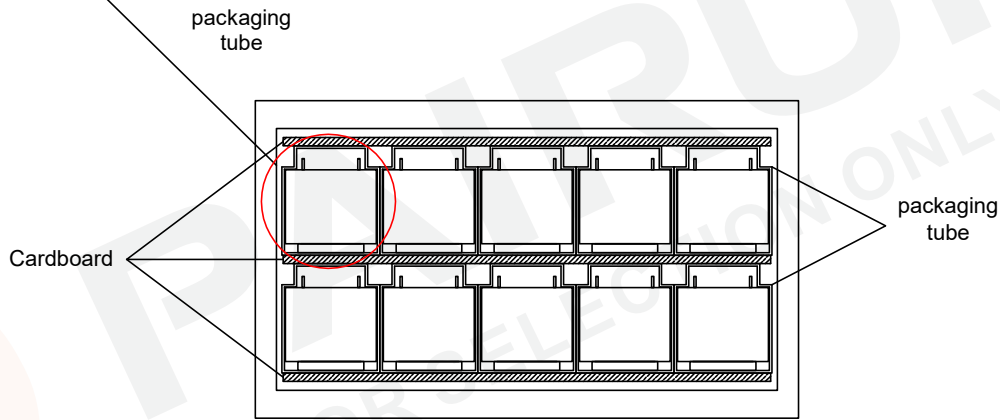

Carton Box Side View

Layer/Carton	Quantity/Tube (pcs)	Quantity/Carton (pcs)	Net weight (g/pc)	Gross weight (g/tube)	Tubes/carton (pcs)	Total weight (kg)	box size Dimensions (mm)
2.0	15.0	150.0	115.0	90.40	10.00	18.72	488*195*114

REV	DESCRIPTION	APPD	DATE

Tianchang Fuan Electronic Co Ltd
www.fuantronics.net
TEL: +86-550-7814888
FAX: +86-550-7831133



Tolerances unless otherwise specified:
(.X)±0.50 (XX)±0.25
Unit of measurement: mm

Make: Qiumei.Liu
Checked: Beson. zhan
Approved: Anson. zhan

DRAWING TITLE
2.80W Encapsulated Transformer
For EI30*18,115VAC Input 50/60Hz
Material Number: A223018XS920

Customer Name:
Document/Rev: 00
Specification Sheet: 3 of 3
Date of Recognition: Jan./02/2020